

CUVE 7500 L

RÉCUPÉRATION

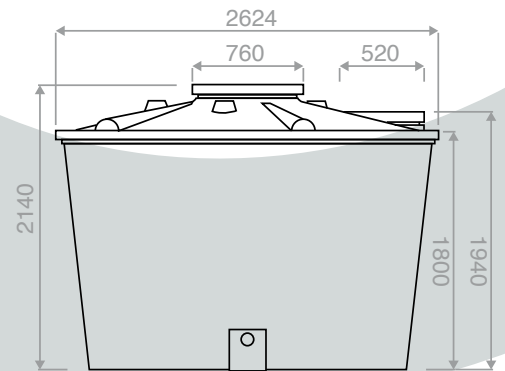

Volume (L)	7500	Ø Haut (M)	2,62
Poids (Kg)	187	Ø Bas (M)	2,18
Longueur (M)	/	Diamètre (M)	/
Hauteur (M)	2,14		



FABRICATION LOCALE EN POLYETHYLENE